

INSTRUCTIONS MANUAL

Installation | Maintenance | Usage | Safety

GAS CHAR BROILER



Model: CBG.06

Model

CBG.06

CBG.08

Image merely illustrative.
Appearance of the equipment
varies by model.



IMG BRASIL - Indústria de Máquinas para Gastronomia Ltda.

CONGRATULATIONS,

You have just purchased an IMG-BRASIL equipment, product of the highest quality, safety and efficiency.

Founded in 1989, IMG-BRASIL is a respected company as one of the best and most complete companies in the field of gastronomy equipment manufacturing.

Constant innovation and improvement of its products, using top-of-line raw materials, ensure superior products consumed in Brazil and in more than 25 countries worldwide.

THE RELIABILITY AND CERTAINTY OF A GOOD PRODUCT ARE IN THE NAME



IMPORTANT:

**PRODUCT FOR PROFESSIONAL USE. DO NOT USE BEFORE READING THE MANUAL CAREFULLY.
IN CASE OF QUESTIONS, PLEASE CONTACT US::**

IMG-BRASIL Gastronomy Machinery Industry Ltda.

CNPJ 11.193.347/0001-14 - CREA 131726-3

Road. Antônio Heil – KM 23 N° 5825 – Neighborhood: Limoeiro – ZIP CODE 88352-502
Brusque – SC – Brasil

Phone/fax. +55 47 3251-5555 - Website: www.metvisa.com.br

INDEX

1. Safety Information.....	4
1.1 General Warnings.....	4
1.2 Mechanical Safety.....	5
2. Technical Characteristics.....	6
2.1 Main Components.....	6
2.2 Technical Data.....	7
2.3 Supply and Disposal of the Equipment Packing.....	7
3. Installation.....	8
3.1 Equipment Layout.....	8
3.2 LPG Gas Installation - Recommendations and Care.....	9
3.3 Safety Procedures and User Instruction.....	10
4. Equipment Use.....	11
4.1 Utility.....	11
4.2 Commands.....	11
4.3 Operating Procedures.....	11
5. Cleaning and Maintenance.....	14
5.1 Cleaning Procedures and Products Used.....	14
5.2 Breakdown Maintenance and Procedures.....	15
5.3 Prolonged Interruption in Use of the Equipment.....	16
6. Analysis and Troubleshooting.....	16
6.1 Problems, possible causes and solutions.....	16
7. Annexes.....	18
Exploded view drawing.....	18
Spare Parts List.....	20



ATTENTION!

The characteristics, pictures and figures presented in this manual should be considered for information. IMG BRASIL reserves the right to make such modifications as may be deemed necessary without prior notice.

1. Safety Information

1.1 General Warnings

- Cautions / precautions must be observed when installing, using, maintaining and discontinuing use of this equipment;
- Before carrying out any operation (assembly, use, maintenance and reuse after prolonged use of the equipment), read the manual carefully;
- The equipment must be used by trained personnel familiar with the use and safety regulations described in this manual;
- This equipment is not intended for use by persons (including children) with reduced physical, sensory or mental capacities, or people with lack of experience and knowledge, unless they have received instructions regarding the use of the equipment or are under the supervision of a person responsible for their safety.
- It is recommended that children be supervised to ensure that they are not playing with the equipment;
- In case of rotation of the personnel that will work with the equipment, the new operator must be educated about the standards and the operation of the same one;
- The operator must use the Adequate PPE (Personal Protective Equipment). As for example: use appropriated gloves to protect the hand from burning by the structure heating of the equipment.
- The operator must always be aware of situations that can cause a risk of accidents and avoid them. For example: turn on the gas regulator knob without lighting the burner, spreading the gas in the environment causing poisoning, fire and explosion risks;
- After reading and clarifying all doubts, this manual should be carefully stored in an easily accessible location, known to all persons who will operate the equipment and make it available to those who will carry out maintenance for any inquiries. Whenever any questions arise, be sure to check the manual. Do not operate the equipment in any way with doubts;
- In the installation, it is essential to make this manual available to the professionals who will do the same;
- Do not install the equipment near flammable materials;
- Before starting cleaning and any type of maintenance, it is essential that the equipment is at room temperature, with the burners off and the gas pressure regulator closed;
- Periodically check the condition of the hose and the entire gas installation part as well as the internal and external part of the equipment (burners, grease collector, gas regulating knob, etc.).



ATTENTION!

Do not perform repairs on your own. Refer servicing to qualified service personnel. Only use original parts in your equipment.

1.2 Mechanical Safety

- Before operating the equipment, make sure that the gas installation does not leak, if the grease collector and the grill are well fitted.



- Only insert products specific to which the equipment is intended onto the grill and never place your hands or flammable products close to or directly on the heated grill.
- When cleaning the equipment, take maximum care. Turn off the burners and close the gas pressure regulator (gas valve). Then wait for the equipment to completely cool down. Never put your hands or cleaning products on the heated grill. For further information on cleaning the equipment, follow the instructions in item 5 of this manual.

The equipment described in this manual complies with regulations against mechanical risks. Security is achieved with:

1. **Fixed structure**, preventing inappropriate access to internal parts, such as the burner set.
2. **Grease collector**, preventing excess oil and process residue from accumulating directly in the tray.
3. **Tray** protects the bench from the accumulation of process residues.
4. **Burner Drawer** that makes it easier for the user to light and see that all burners have lit, avoiding gas leaks.
5. **Burner Protection** reduces heat at the front of the equipment. Preventing overheating of the Gas Regulator knobs.

To view the parts described above, see the image in item 2.1 (Main Components – page 6) of this manual.



ATTENTION!

Always that some item referred to safety be removed from the equipment (for example, for cleaning or maintenance), replace it in place and confirm that it is performing its function correctly.

2. Technical Characteristics

2.1 Main Components

For the equipment described in this manual, safety in use, cleaning, maintenance and maximum hygiene are guaranteed by the design and special design of all parts, as well as the use of stainless steel and other materials suitable for contact with the foods.

The equipment was designed with the following characteristics:

- Grill and structure made of stainless steel, which resists attacks from various corrosive agents, such as most organic acids, organic substances in general, alkalis, oxy-salts, etc.

Note: stainless steel is attacked by sulfuric acid, and also does not resist hydrochloric acid, diluted sulfuric acid, chlorides and halides in general.

- Burner Drawer, where the Front Protection is made of stainless steel, making the equipment with a modern design and facilitating cleaning, in addition to giving the equipment a longer useful life. Carbon steel burners with high temperature paint and burner protection made from zinc-plated steel. Both materials have excellent anti-corrosion protection that gives the piece greater durability;
- Carbon steel structure with high temperature paint;
- Grease collector with steel structure and stainless steel front;
- Tray made of carbon steel coated with epoxy electrostatic paint, excellent anti-corrosion protection.

See below the main components of the equipment:



Note: For exploded drawing with spare parts list, see annexes.

2.2 Technical Data

Model	Nominal Measures LxHxW (mm)	NET WEIGHT (kg)	Quantity Burners (units)	Gas Consumption per Burner (kg/h)	Maximum Gas Consumption (kg/h)
CBG06	565x220x565	16,7	02	0,18	0,36
CBG08	765x220x565	20,8	03	0,18	0,54



ATTENTION!

Characteristics like: model, serial number and protection grade of the equipment are provided on the label (figure below).

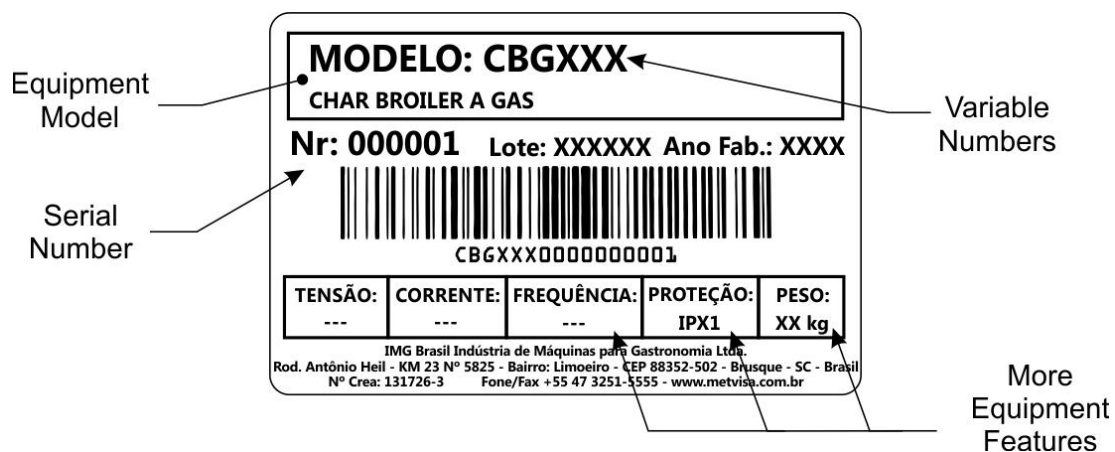

2.3 Supply and Disposal of Equipment Packaging

The equipment is packed with wood or cardboard to ensure its perfect integrity during transport and is accompanied by the following documents:

- Instruction Manual for Installation. Use, Maintenance and Safety;

IMPORTANT

The packaging components (cardboard, wood, foam, strips, etc.) are products that can be assimilated to municipal solid waste and can be disposed of without difficulty. If the equipment is installed in countries with different standards, dispose of the packaging in accordance with current regulations. Dispose of the product correctly to help protect the environment. For more information on recycling, contact your local authorities, waste disposal service or the shop where you purchased the product.

3. Installation

3.1 Equipment Layout

When installing, it is essential to make this manual available to the professionals who will carry it out.

To ensure correct operation and safety, the equipment must be positioned in a ventilated environment and on a sufficiently large, well-leveled, dry and stable support surface, away from heat sources and water taps, and at a medium height. 80 cm. Install your equipment leaving a free area at the front and top, and a distance of at least 20 cm at the sides and rear, so that there is enough space to carry out inspection, maintenance, cleaning, use and connection of the gas supply hose.

Equipment top part with free space

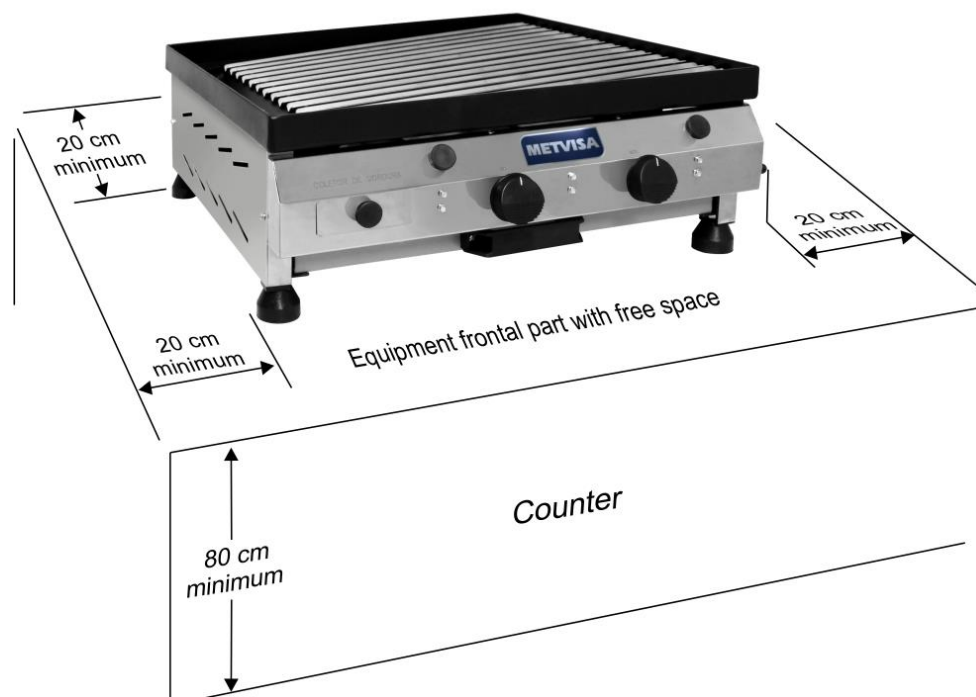

It is recommended to install a hood or extractor above the equipment to collect vapors, preventing them from spreading into the environment.

IMPORTANT

To install the hood or extractor fan, follow the manufacturer's instructions, as this item is not included with the equipment.



ATTENTION!

This equipment uses LPG (liquefied petroleum gas) for heating, and cannot be installed in closed environments where there is no air renewal, as this gas is highly toxic.

Keep the gas cylinder at least 1.5 m away from sockets, switches, electrical switches, or any device subject to sparks or flames, where these in contact with LPG gas could cause an explosion, causing serious accidents with risk of death to the operator.

Do not install the equipment near flammable materials or products.



ATTENTION!

The installation and the place where the equipment will be placed must comply with the rules of risk prevention and safety at work (Regulatory Norm NR-12 for Brazil or according to the regulatory standard in force in your country).

The manufacturer is not responsible for possible direct or indirect damages caused by non-compliance with said standards and other instructions presented in this manual.

3.2 LPG Gas Installation - Recommendations and Care

Check that the place where the equipment will be installed is ventilated and in accordance with the Rules for the Prevention of Risks at Work and Safety at Work on Machines and Equipment (Regulatory Norm NR-12), and periodic inspections by a technician are recommended to ensure that its components are in working condition.



ATTENTION!

The equipment must be placed in an airy place, but without an air current, thus avoiding the flames in the burners going out, causing gas leaks.

The gas installation must be done by a qualified technician for this function and observing the safety rules.

The equipment must be installed with the following recommendations and items described below **BUT NOT SUPPLIED WITH THE EQUIPMENT**:

- **Gas cylinder** – for this equipment, 01 cylinder with a minimum mass of 13 kg (code P13) of LPG (liquefied petroleum gas) will be required. The cylinder must comply with the ABNT 8460 standard for Brazil or according to the regulatory standard in force in your country. Check the product warranty seal. If you have violated, do not install.
- **Pressure Regulator and Gas Register** – use only low-pressure regulator (2.8 Kpa) and with certification, embossed inscription NBR 8473. When installing the register on the cylinder, turn the butterfly nipple to the right, until it is firm. Never use tools to perform this operation.

• **Hose** – the INMETRO-certified model has the NBR 8613 engraving, made of transparent PVC plastic with a yellow stripe. The equipment is manufactured with connection for 1/2” hoses. The hose must not cross or be embedded in walls, and must not make any type of splice (welding or gluing). Fix the ends only with appropriate clamps. Never use wires or ribbons. Always check the expiry date of the hose.

IMPORTANT

In addition to the instructions given in this manual, it is also recommended to follow the cylinder, pressure regulator and hose manufacturer's instructions, as these item is not included with the equipment.



ATTENTION!

Change the pressure regulator every 5 years or when it is defective.

Always use the gas cylinder in an upright position. Never overturn, pour or tilt the cylinder, as the gas may flow into the liquid phase, canceling the pressure regulator function, which can cause serious accidents.

Never install the cylinder close to heated surfaces, and keep the gas conductive hose protected from heat so it does not melt, causing fire or other accidents.



ATTENTION!

This equipment operates with LOW PRESSURE GAS. If your supply network has high pressure, have the low-pressure outlet valve checked by a technician.

If the equipment is switched on at high pressure, the components will be damaged, in addition to creating risks for the operator.

After installation and for your safety, check for gas leaks using soap suds only. If there is a leak, inform the technician to repeat the installation.

If the leak persists, take the cylinder to a well-ventilated place and notify the company that sells or distributes the cylinder.

IMPORTANT

The manufacturer is not responsible for possible direct or indirect damage caused by non-compliance with the rules and instructions presented in this manual.

3.3 Safety Procedures and User Instruction

The professional who sells the equipment must instruct the user on the correct functioning of the equipment and must hand over this instruction manual.

The user must be informed of the necessary safety measures and must respect them, as well as all measures described in this manual.

Your equipment has mechanical protections (see item 1.2 Mechanical Safety). Removing or tampering with these safety components can cause serious risks to the operator's upper limbs.

4. Equipment Use

4.1 Utility

This equipment is exclusively intended for roasting food in general.

4.2 Commands

The equipment consists of gas regulator knobs (flame level) on the front. Check the adjustment positions in the following image:

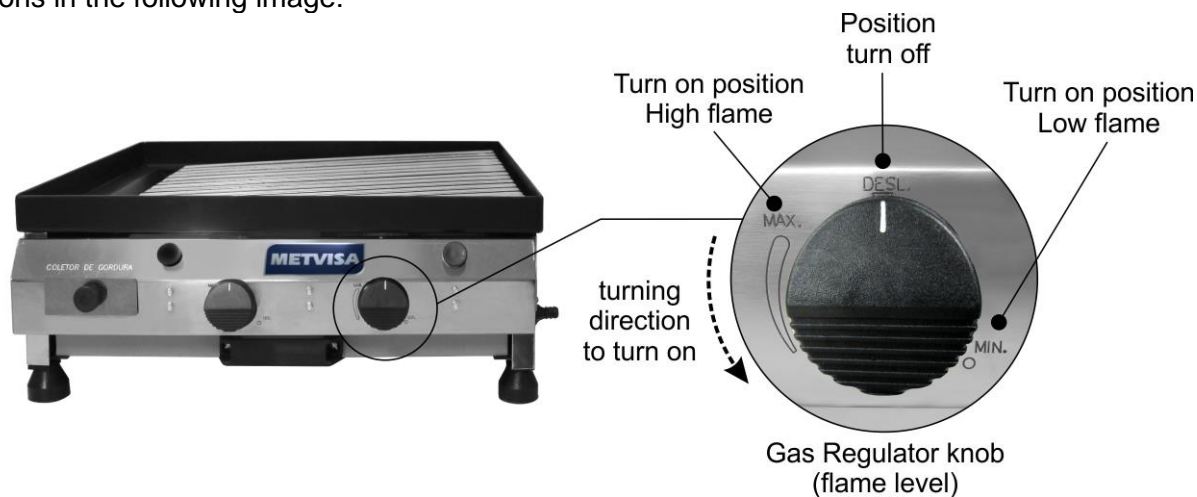

4.3 Operating Procedures

Before operating the equipment, thoroughly clean it, especially the grill that will come into contact with food. The equipment is supplied with a protective film on the stainless steel parts that must be removed before use. Clean the equipment with the burners turned off, the gas pressure regulator (gas valve) closed and the equipment at room temperature. Follow the cleaning instructions in item 5 of this manual (below).

After these initial precautions, make sure that the gas hose connections are correctly fixed and that there are no leaks.



ATTENTION!

For the first use of the equipment, it is necessary to cure the paint on the burners. To do this, empty equipment must be turned on for a minimum period of 10 minutes. Follow the lighting instructions in the operation section below.

During the paint curing procedure, odor and smoke will be released due to the burning of the paint.

Turn off the equipment and wait until it reaches room temperature. After that, your equipment will be available for use.

• **Operation:** The equipment can only be operated after checking the correct arrangement of the equipment, instructed in item 3.1, and after following the care and recommendations of the gas installation, according to the guidelines in items 3.2 and after removing the protective film of the equipment.

Check the following operating instructions:

1. The equipment is switched on manually. Open the gas pressure regulator (gas valve);
2. Carefully open the burner drawer;
3. Press the gas regulator knob and turn it to the on position;
4. For correct and safe lighting, use an automatic type lighter. With the lighter in hand, bring the tip 1 or 2 cm closer to the burner to light it;

IMPORTANT

The automatic lighter does not come with the equipment, so always check the instructions for use on the packaging, which may vary depending on the brand and model.

5. Repeat the procedure to light each burner;
6. Adjust the flame level using the gas regulator knob and observe the quality of the flame. The ideal flame should be blue in color. Follow the instructions below to adjust the flame:

• Each burner tube has a flame regulator, which is pre-adjusted at the factory. To adjust the ideal flame for each burner, make sure the burners are turned off and pull out the burner drawer. At the bottom of the drawer, you can see the clamp. Loosen (using an appropriate tool) the clamp fixing screw and slide it onto the burner tube, allowing more or less air intake.

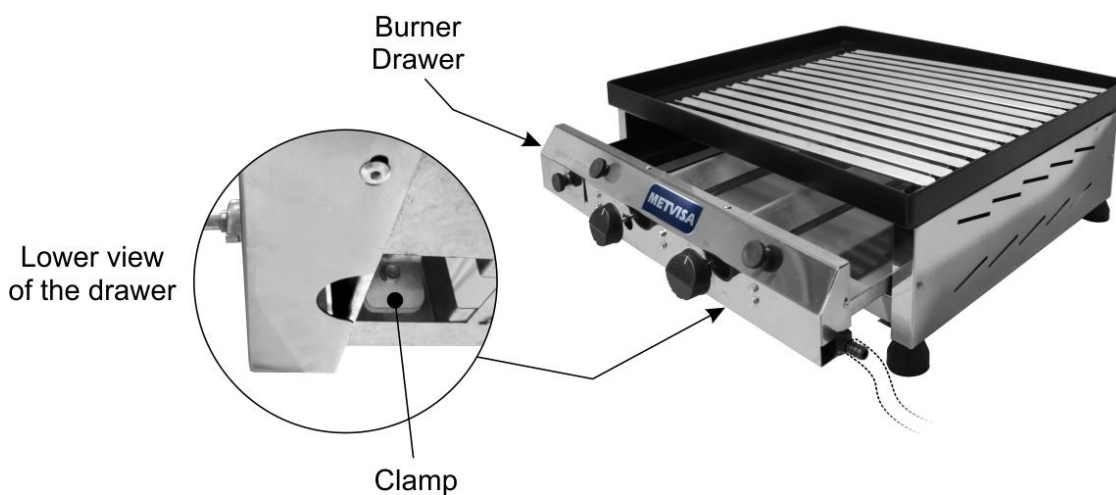



ATTENTION!

After opening the gas valve, quickly light the burners, as the gas will already be spreading into the air.

Light one burner at a time, and as many as necessary to carry out the necessary operation.

Make sure the burners are completely lit.

If ignition fails and if you smell gas in the room, do not light.

Wait a few minutes for the air to renew in the room, and only then repeat the lighting process.

7. We recommend adding a thin layer of water to the tray and grease collector to prevent combustion of residues and facilitate cleaning;
8. Wait approximately 15 minutes for preheating and place the food to be grilled on the grill. Note that the central region of the grill is the area with the highest concentration of heat;
9. Using tongs, turn the food until the desired doneness is achieved;
10. After removing the food, remove excess oil, fat and process residues with the scraper towards the fat collector;



Use the scraper to remove excess of residues from the process



ATTENTION!

Always keep the grease collector inserted in the equipment and empty it constantly, this will prevent excess grease from overflowing and leaking onto the burners, causing fire or other accidents.

11. After finishing work, turn off the burners by turning the gas regulator knob to the off position. Close the gas pressure regulator (gas valve).
12. Wait until your equipment reaches room temperature before cleaning.



ATTENTION!

After finishing the work stage and turning off the burners, close the gas pressure regulator (registration), as if it remains open, the pressure exerted on the hose could damage or rupture it, which could cause a fire or other accidents.



ATTENTION!

During operation, hot vapors and splashes of superheated oil or fat may be emitted. Always use PPE (Personal Protective Equipment).

IMPORTANT

Do not start the cooking process if there is food residue on the grill, this could cause contamination with bacteria.

5. Cleaning and Maintenance

5.1 Cleaning Procedures and Products Used

Your equipment was built with first-line materials, so use it properly and you will obtain great satisfaction. Always keep your equipment clean and well-cared for, which will make it much more durable.

Daily cleaning of the equipment must be carried out for good operation and durability. Preventing the accumulation of bacteria which can cause contamination in food.

If your equipment is supplied with a protective film on the stainless steel parts, it must be removed before the first cleaning.



ATTENTION!

Before carrying out maintenance or cleaning, ensure that the equipment has the burners turned off, the gas pressure regulator (register) closed and at room temperature;



ATTENTION!

Do not use water jet or steam cleaner to clean the equipment.

IMPORTANT

This equipment is not intended to be immersed in water for cleaning.

Follow the instructions below to learn what special care is taken with the equipment.

The detachable parts (grease collector, tray and grill) must be removed from the equipment and washed with warm water and soap or neutral detergent. Remove excess residue from the grill using the scraper that comes with the equipment. Clean the corners well, eliminating all residue from the process.

Even though it is mobile, the burner drawer cannot be immersed in water and never use water jets to clean it, as this will damage the burners.

When cleaning the burner drawer and structure, dilute soap, neutral detergent, or ammonia-based remover in warm water and apply with a soft cloth. Using a cloth dampened with water, rinse and then dry the pieces with a dry, soft cloth.

Never use abrasive products (soap, brushes or steel wool) and substances containing acids or chlorine on any stainless steel surface, as this will damage the parts and cause corrosion.



ATTENTION!

It is extremely important that the products used for cleaning ensure maximum hygiene and that they are non-toxic.

5.2 Breakdown Maintenance and Procedures

The operator must be instructed to carry out routine inspections, making small adjustments, cleaning and observing signs of breakdowns that may occur. Examples include: checking for strange noises indicating gas leaks; burners that do not light; the non-execution by the equipment to the service to which it is proposed; among others. Actions like these are indispensable to guarantee a longer equipment life.



ATTENTION!

When maintenance is carried out (even if minor adjustments are made), always check that the equipment has the burners off, the pressure regulator (register) of the gas closed and the equipment be at room temperature;

It is recommended that each 6 months be made preventive maintenance, checking and adjusting the loose, cleaning the internal parts, and others. Detecting broke parts or without the correct functionality the worker needs to exchange the parts, always using original parts only.

By carrying out preventive maintenance, the inconvenience of having the equipment stopped when it is most needed is eliminated, the cost of maintenance is reduced and the risk of accidents is reduced.

Follow the equipment maintenance and adjustment recommendations:

- Change the pressure regulator every 5 years or when it is defective;

- Check the expiration date of the gas hose and follow other instructions as recommended by the manufacturer;
- After finishing work with the equipment, keep the gas pressure regulator (register) closed, avoiding pressure on the hose;
- The gas outlet holes on the burners must always be unobstructed. If they become clogged, use a needle to clean the stove nozzles;
- The ideal flame should be blue in color. Each burner tube has a flame regulator, follow the adjustment instructions in item 4.3 (operating procedures – page 12);



ATTENTION!

Preventive maintenance requires a trained professional.

Whenever an item related to the safety of the equipment is removed (such as when performing maintenance), put it back in its proper place and confirm that they are performing their function correctly.

Detecting broke parts or without the correct functionality, please contact the nearest authorized service center. www.metvisa.com.br

5.3 Prolonged Interruption in Use of the Equipment

When you have to leave the equipment stopped for an extended period of time, perform a thorough cleaning, including the accessories. It is advisable to protect all parts of the equipment with white petroleum jelly or with suitable products that are commercially available. You must also protect the equipment from dust by covering it with a nylon or other material.

6. Analysis and Troubleshooting

6.1 Problems, possible causes and solutions

IMG quality products are designed with materials and components that guarantee a longer service life for your equipment. However, due to natural wear, improper use or lack of maintenance, the equipment may have irregularities in its operation.

In the following table, you can see possible causes and solutions:

PROBLEMS	POSSIBLE CAUSES	SOLUTIONS
Burners do not light	Lack of gas.	Check whether there is gas in the cylinder, whether the gas cylinder valve is open, whether the gas hose is connected and whether the gas regulator is open.
	Broken Gas Register.	Send the equipment to the nearest authorized service station or contact the factory.
	Clogged burner.	Unblock the burner holes using a needle to clean the stove nozzles. If this does not solve the problem, send the equipment to the nearest authorized service station or contact the factory.
	Gas Leak.	Check below the possible causes and solutions for gas leaks (pages 16 and 17).
Yellow flame, equipment generating soot.	Problem mixing gas with oxygen.	Each burner tube has a flame regulator, follow the adjustment instructions in item 4.3 (operating procedures page 12);
Gas Leak.	Burst, loose or broken gas register	Send the equipment to the nearest authorized service station or contact the factory, as there is a risk of accidents.
	Registration injection nozzle out of position.	Send the equipment to the nearest authorized service station or contact the factory, as there is a risk of accidents.
	Defective gas cylinder.	Check for gas leaks using soap suds only. If there is a leak, inform the technician so that he can repeat the installation. If the leak persists, take the cylinder to a well-ventilated place and notify the cylinder reseller or distributor.
Gas Leak.	Gas cylinder installed in horizontal position.	Install the cylinder in a vertical position. Never turn, lay down or tilt the cylinder, as the gas could flow in the liquid phase, nullifying the function of the pressure regulator, which could cause serious accidents.
Difficulty adjusting the flame	Burst, loose or broken gas register	Send the equipment to the nearest authorized service station or contact the factory, as there is a risk of accidents.
	Gas regulator knob, broken or worn.	To replace the regulator k, contact the factory or send the equipment to Authorized Technical Assistance.
Lack of gas during operation	Lack of gas.	Check whether there is gas in the cylinder, whether the gas cylinder valve is open, whether the gas hose is connected and whether the gas regulator is open.
	broken gas register	Send the equipment to the nearest authorized service station or contact the factory, as there is a risk of accidents.

For more information and clarification, contact the Authorized Technical Assistance nearest you. See list of technical assistance on our website: www.metvisa.com.br

Exploded View Drawing

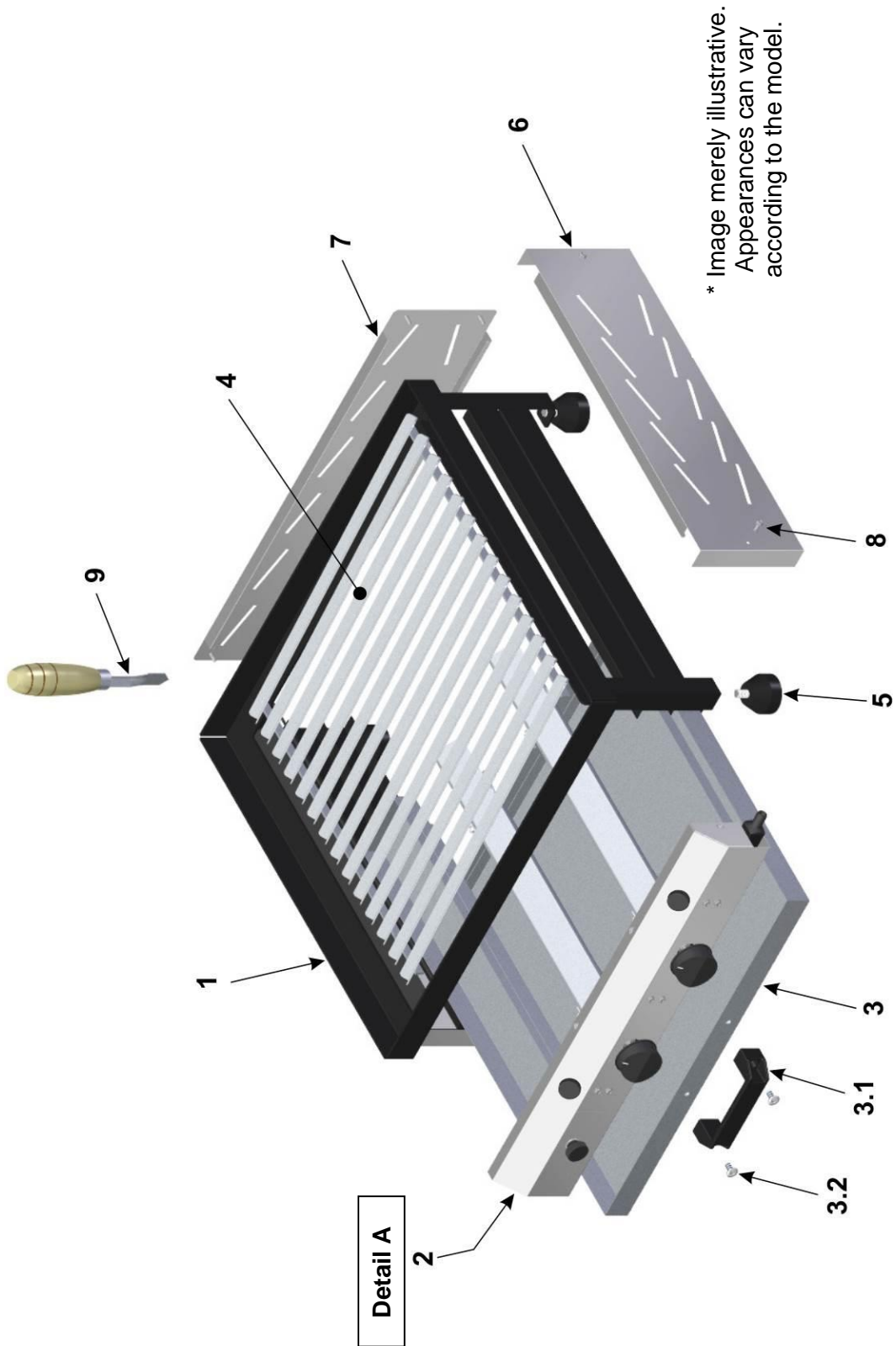

Exploded View Drawing

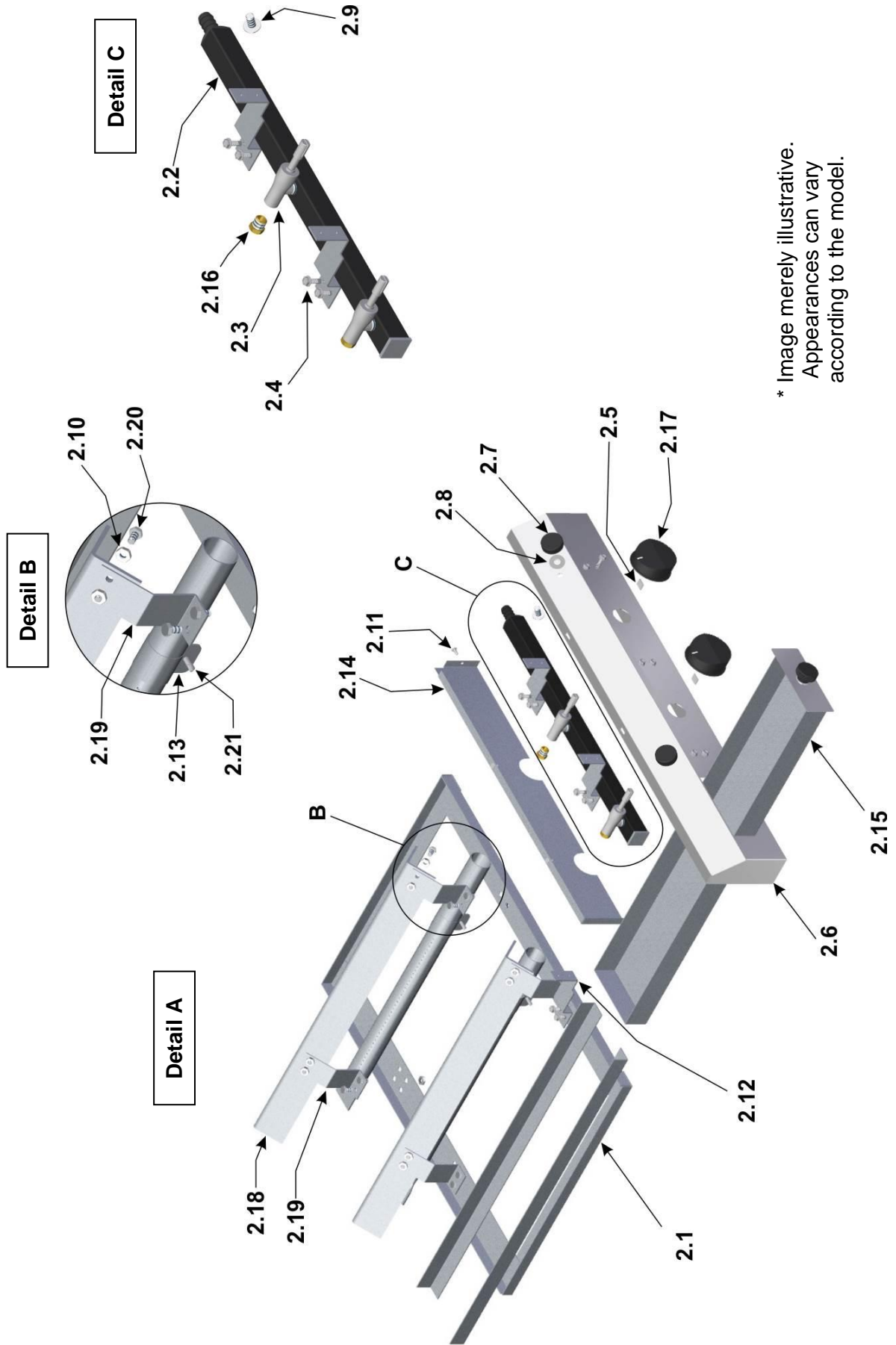

* Image merely illustrative.
Appearances can vary
according to the model.

Spare Parts List

Position	Code	Description	Quantity	Model
1	ETR140	Structure	01	CBG.06
	ETR144		01	CBG.08
2	CJT934	Burner Drawer	01	CBG.06
	CJT988		01	CBG.08
2.1	SBT467	Burner Support	01	CBG.06
	SBT499		01	CBG.08
2.2	CJT933	Gas Tube Set	01	CBG.06
	CJT989		01	CBG.08
2.3	TNR003	Gas Tap - Gas Valve	02	CBG.06
			03	CBG.08
2.4	PRA014	Drilling Hex Screwdriver	12	CBG.06
			16	CBG.08
2.5	CRC783	Register support	02	CBG.06
			03	CBG.08
2.6	PTC192	Welded Front Protection	01	CBG.06
	PTC203		01	CBG.08
2.7	MNL011	Handle	02	*
2.8	ARL010	Flat Stainless Washer	04	*
2.9	PRR009	Machine Screw round	02	*
2.10	POS020	Stainless Hex Nut	16	CBG.06
			24	CBG.08
2.11	RBT001	Rivet	03	CBG.06
			04	CBG.08
2.12	SBT473	Painted Gas Tube Support	01	*
2.13	CRC849	Oxygen Regulator	02	CBG.06
			03	CBG.08
2.14	PTC193	Internal Burner Protection	01	CBG.06
	PTC205		01	CBG.08
2.15	CXA021	Mounted Grease Collector	01	*
2.16	IJT006	Gas Registration Injector	02	CBG.06
			03	CBG.08
2.17	BOT021	Gas Regulator Knob	02	CBG.06
			03	CBG.08
2.18	CAN130	Deflector Angle	02	CBG.06
			03	CBG.08
2.19	SBT470	Deflector Angle Support	04	CBG.06
			06	CBG.08
2.20	PRS332	Stainless Hex Screw	16	CBG.06
			24	CBG.08
2.21	RBT004	Rivet	02	CBG.06
			03	CBG.08
3	BDJ055	Tray	01	CBG.06
	CJT1001		01	CBG.08
3.1	ACA009	Plastic Handle	01	*
3.2	PRR009	Machine Screw round	02	*
4	GRA011	Grill	01	CBG.06
	GRA012		01	CBG.08
5	PEP019	Rubber Foot	04	*
6	REF037	Side Covering	02	*
7	REF061	Back Coating	01	CBG.06
	REF040		01	CBG.08
8	PRA014	Drilling Hex Screwdriver Stainless Steel	08	*
9	RPV012	Scraper	01	*

* Item applied to all Char Broiler models.

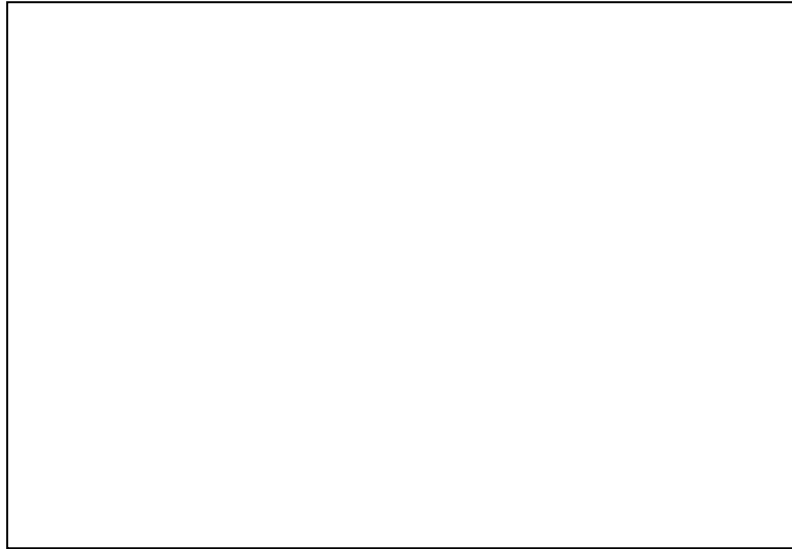

IMG-BRASIL Gastronomy Machinery Industry Ltda.

CNPJ 11.193.347/0001-14 - CREA 131726-3
Road Antônio Heil - KM 23 N° 5825 - Neighborhood: Limoeiro
ZIP CODE 88352-502 - Brusque - SC - Brazil
Phone/fax. +55 47 3251-5555 - Site: www.metvisa.com.br
Mail: sac@metvisa.com.br - export@metvisa.com.br



Know our complete
line of products.