



INSTRUCTION MANUAL

Installation | Maintenance | Use | Safety

Shawarma Grill Machine



Models

ACGE.2

ACGE.4

Image merely illustrates.

Model: ACGE.4

CONGRATULATIONS,

You have just purchased an IMG-BRASIL equipment, product of the highest quality, safety and efficiency.

Founded in 1989, IMG-BRASIL is a respected company as one of the best and most complete companies in the field of gastronomy equipment manufacturing.

Constant innovation and improvement of its products, using top-of-line raw materials, ensure superior products consumed in Brazil and in more than 25 countries worldwide.

THE RELIABILITY AND CERTAINTY OF A GOOD PRODUCT ARE IN THE NAME

IMG BRASIL PRODUCT MANUFACTURER



IMPORTANT:

**PRODUCT FOR PROFESSIONAL USE. DO NOT USE BEFORE READING THE MANUAL CAREFULLY.
IN CASE OF QUESTIONS, PLEASE CONTACT US::**

IMG-BRASIL Gastronomy Machinery Industry Ltda.

CNPJ 11.193.347/0001-14 - CREA 131726-3

Road. Antônio Heil – KM 23 N° 5825 – Neighborhood: Limoeiro – ZIP CODE 88352-502

Brusque – SC – Brasil

Phone/fax. +55 47 3251-5555 - Website: www.metvisa.com.br

INDEX

1. Safety Information	4
1.1 General Warnings.....	4
1.2 Mechanical Safety	5
1.3 Electrical Safety.....	5
2. Technical Characteristics	6
2.1 Main Components.....	6
2.2 Technical Data.....	7
2.3 Supply and Disposal of Equipment Packaging.....	8
3. Installation	8
3.1 Equipment Layout.....	8
3.2 Electrical Connection.....	10
3.3 LPG Gas Installation - Recommendations and Care.....	11
3.4 Safety Procedures and User Instruction.....	13
4. Equipment Use	13
4.1 Utility.....	13
4.2 Commands.....	13
4.3 Operating Procedures.....	14
5. Cleaning and Maintenance	18
5.1 Cleaning Procedures and Products Used.....	18
5.2 Breakdown Maintenance and Procedures.....	19
5.3 Prolonged Interruption in Use of the Equipment.....	20
6. Analysis and Troubleshooting	20
6.1 Problems, possible causes and solutions.....	20
7. Useful Life of the Equipment and its Components	21
8. Applicable Standards	21
9. ANEXXES	22
Electrical Schematic.....	22
Exploded View Drawing.....	23



ATTENTION!

The characteristics, pictures and figures presented in this manual should be considered for information. IMG BRASIL reserves the right to make such modifications as may be deemed necessary without prior notice.

1. Safety Information

1.1 General Warnings

- Cautions / precautions must be observed when installing, using, maintaining and discontinuing use of this equipment;
- Before carrying out any operation (assembly, use, maintenance and reuse after prolonged use of the equipment), read the manual carefully;
- The equipment must be used by trained personnel familiar with the use and safety regulations described in this manual;
- This equipment is not intended for use by persons (including children) with reduced physical, sensory or mental capacities, or people with lack of experience and knowledge, unless they have received instructions regarding the use of the appliance or are under the supervision of a person responsible for their safety.
- It is recommended that children be supervised to ensure that they are not playing with the equipment;
- In case of rotation of the personnel that will work with the equipment, the new operator must be educated about the standards and the operation of the same one;
- The operator must use the **Adequate PPE** (Personal Protective Equipment). As for example: use appropriated gloves to protect the hand from burning by the structure heating of the equipment.
- The operator must always be aware of situations that can cause a risk of accidents and avoid them. For example: turn on the gas regulator button without lighting the burner, spreading the gas in the environment causing poisoning, fire and explosion risks;
- After reading and clarifying all doubts, this manual should be carefully stored in an easily accessible location, known to all persons who will operate the equipment and make it available to those who will carry out maintenance for any inquiries. Whenever any questions arise, be sure to check the manual. Do not operate the equipment in any way with doubts;
- In the installation, it is essential to make this manual available to the professionals who will do the same;
- Do not install the equipment near flammable materials;
- Before starting cleaning and any type of maintenance, it is essential that the equipment is at room temperature, with the burners off and the gas pressure regulator closed;
- Periodically check the condition of the cables and electrical parts, hose and the entire gas installation part as well as the internal and external part of the equipment (burners, internal structure, gas regulating buttons, etc.).
- These equipments are intended to be used for commercial applications, for example in restaurant kitchens, canteens, hospitals and in commercial enterprises such as bakeries, butchers, etc., but not for continuous mass production of food.



ATTENTION!

Do not perform repairs on your own. Refer servicing to qualified service personnel. Only use original parts in your equipment.

1.2 Mechanical Safety

- Before operating the equipment, make sure that the gas installation does not leak.
- Insert only specific products into the roaster for which the equipment is intended and never place your hands or inflammable products, close to or directly on the roaster.
- When cleaning the equipment, be extremely careful. Disconnect the equipment from the electrical network and close the gas valves on the cylinders. Then wait for the roaster to completely cool down. Never put your hands or cleaning products on the heated roaster. For further information on cleaning the equipment, follow the instructions in item 5 of this manual.

The equipment described in this manual complies with the mechanical type hazard regulation. The requirements of the Brazilian standard were observed: INMETRO (see item 8 Applicable Standards).

Security is ensured with:

- **Structure and internal coating** prevent inappropriate access to internal parts, such as infrared burners and motor during the process;
- **Grease collector**, preventing grease and process residue from accumulating in the tray.

To view the parts described above, refer to the image in item 2.1 (Main Components – page 7) of this manual.



ATTENTION!

Always that some item referred to safety be removed from the equipment (for example, for cleaning or maintenance), replace it in place and confirm that it is performing its function correctly.

1.3 Electrical Safety

- Periodically check the condition of cables and electrical parts;
- If the power cord is damaged, it must be replaced with a new one. The exchange must be carried out by the manufacturer, an authorized agent or a qualified person in order to avoid risks;
- Do not use water jets or steam cleaners, as it may cause electric shock. To clean your equipment, follow the instructions in item 5 of this manual;
- Do not work with the equipment in damp places, or with wet clothes and shoes. Put on proper footwear, this will avoid electric shocks and even death;
- Place the equipment on a firm, dry and well-leveled surface;
- Never carry out any maintenance, adjustment or disassembly operation on the equipment with it turned on. For such procedures, make sure that it is turned off, removing the plug from the electrical network, turning off the burners, closing the gas pressure regulator (register) and verifying that the roaster is at room temperature;

- Do not use extension cords or adapters with various other equipments connected to them. This could cause fire or overload;
- Grounding on this equipment is mandatory;
- Be careful not to let the electric cable touch any hot surface;
- Do not use charcoal or similar fuels in this equipment.

Removing or tampering with any of the security systems can cause serious accidents.

The components used for safety against electrical hazards have been selected in accordance with applicable standards. Given the perfect insulation of all electrical parts and the excellent resistance of all the materials used, this equipment is capable of carrying out the tasks it is intended to do.



ATTENTION!

Always that some item referred to safety be removed from the equipment (for example, for cleaning or maintenance), replace it in place and confirm that it is performing its function correctly.

2. Technical Characteristics

2.1 Main Components

For the equipment described in this manual, safety in use, cleaning, maintenance and maximum hygiene are guaranteed by the design and special design of all parts, as well as the use of stainless steel and other materials suitable for contact with the foods.

The equipment was designed with the following characteristics:

- Structure, external structure, deflector, tray, grease collector and spatula made of stainless steel, which has superior corrosion resistance than other steels. It is a material resistant to the attack of several corrosive agents;
- Back and bottom coating in galvanized steel, an excellent anti-corrosion protection that gives greater durability to the part.
- Burners with heat emitted by infrared radiation;

See below the main components of the equipment:

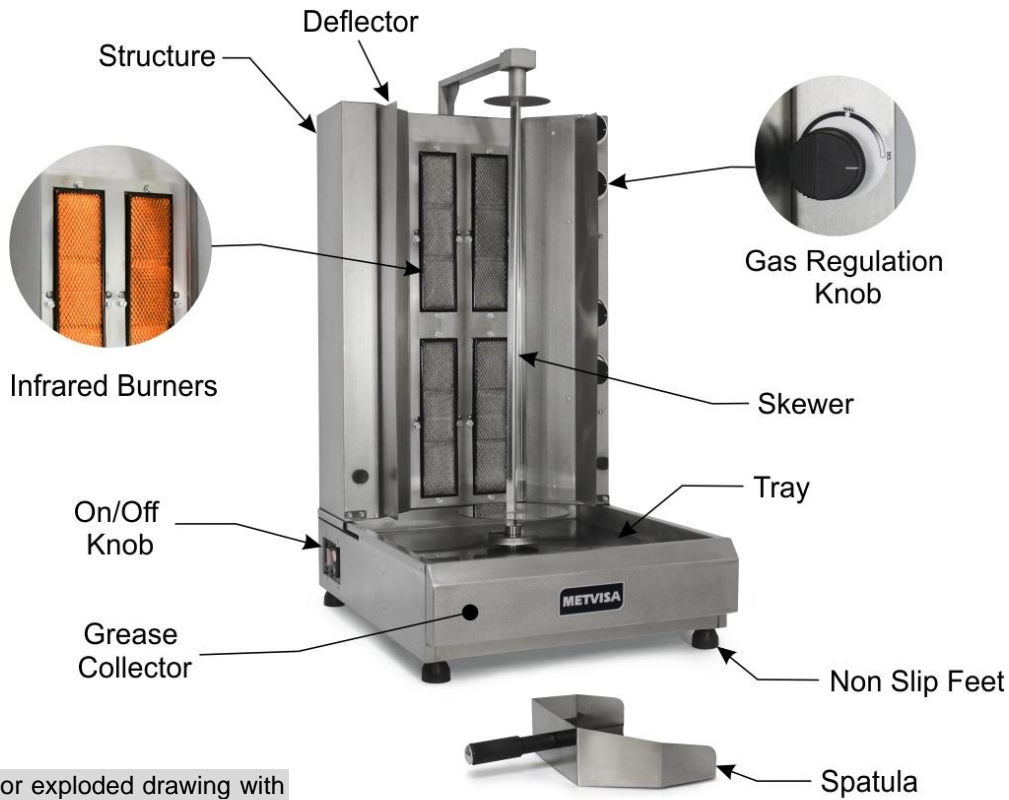

Note: For exploded drawing with spare parts list, see annexes.

2.2 Technical Data

Model	Voltage (V)	Freq. (Hz)	Net Weight (kg)	Nominal Measures LxHxW (mm)	Rate (A)	Skewer Rotation (rpm)	Gas Consumption (kg/h)	Capacity (kg)	Quantity Infrared Burners	Preparation Time Approx. (min)**
ACGE2110M604	110	60	20,0	550x720x695	0,03	3	0,4	12	2	10
ACGE2220M501	220	50	20,0	550x720x695	0,03	3	0,4	12	2	10
ACGE4127M605	127	60	26,0	550x1100x695	0,03	3	0,8	20	4	10
ACGE4220M605	220	60	26,0	550x1100x695	0,02	3	0,8	20	4	10
ACGE4110M604	110	60	26,0	550x1100x695	0,03	3	0,8	20	4	10
ACGE4220M501	220	50	26,0	550x1100x695	0,02	3	0,8	20	4	10
ACGE4220M502	220	50	26,0	550x1100x695	0,02	3	0,8	20	4	10
ACGE4220M504	220	50	26,0	550x1100x695	0,02	3	0,8	20	4	10

* Estimated 10 minutes to roast the first layer of meat. Preparation time may vary depending on the type of meat. Frozen or brine-seasoned meats usually take longer to cook than other foods. External factors such as heat, cold and wind influence the time to bake and the temperature required for each type of food.



ATTENTION!

Characteristics like: model, serial number and voltage of the equipment are provided on the label (figure below). Before installation, check that the power supply voltage of the equipment corresponds to that of the mains.

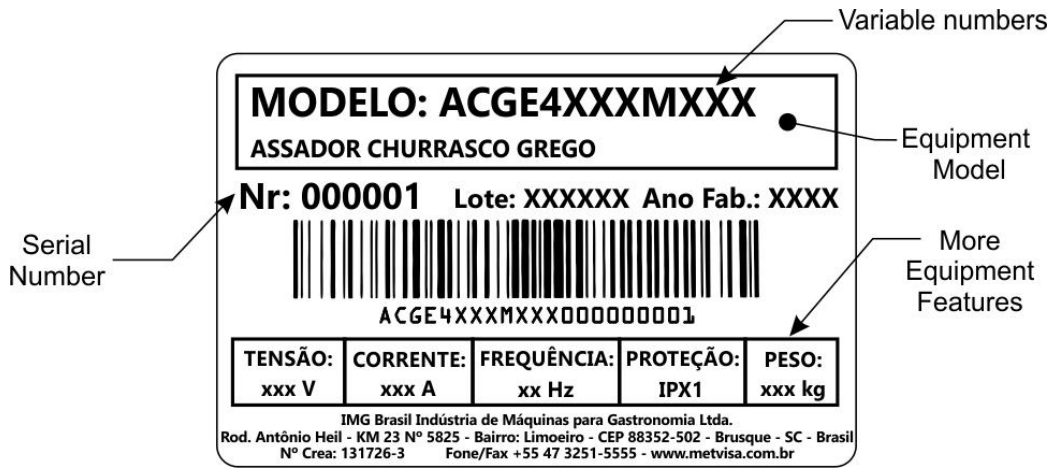

2.3 Supply and Disposal of Equipment Packaging

The equipment is packed with wood or cardboard to ensure its perfect integrity during transport and is accompanied by the following documents:

- Instruction Manual for Installation. Use, Maintenance and Safety;

IMPORTANT

The packaging components (cardboard, wood, foam, strips, etc.) are products that can be assimilated to municipal solid waste and can be disposed of without difficulty. If the equipment is installed in countries with different standards, dispose of the packaging in accordance with current regulations. Dispose of the product correctly to help protect the environment. For more information on recycling, contact your local authorities, waste disposal service or the shop where you purchased the product.

3. Installation

3.1 Equipment Layout

When installing, it is essential to make this manual available to the professionals who will carry it out.

To ensure the correct functioning and safety, the equipment must be positioned in a ventilated environment and on a sufficiently wide, well-leveled, dry and stable support surface, away from heat sources and water taps, in a place where there is no heavy traffic of people. Install your equipment leaving a space of 1 m at the top (due to heating) and a clear area at the front. Leave a distance of at least 20 cm on the sides and an area of 30 cm at the back for gas installation. The area must have sufficient space for inspection, maintenance, cleaning, use and connection of the gas supply hose.

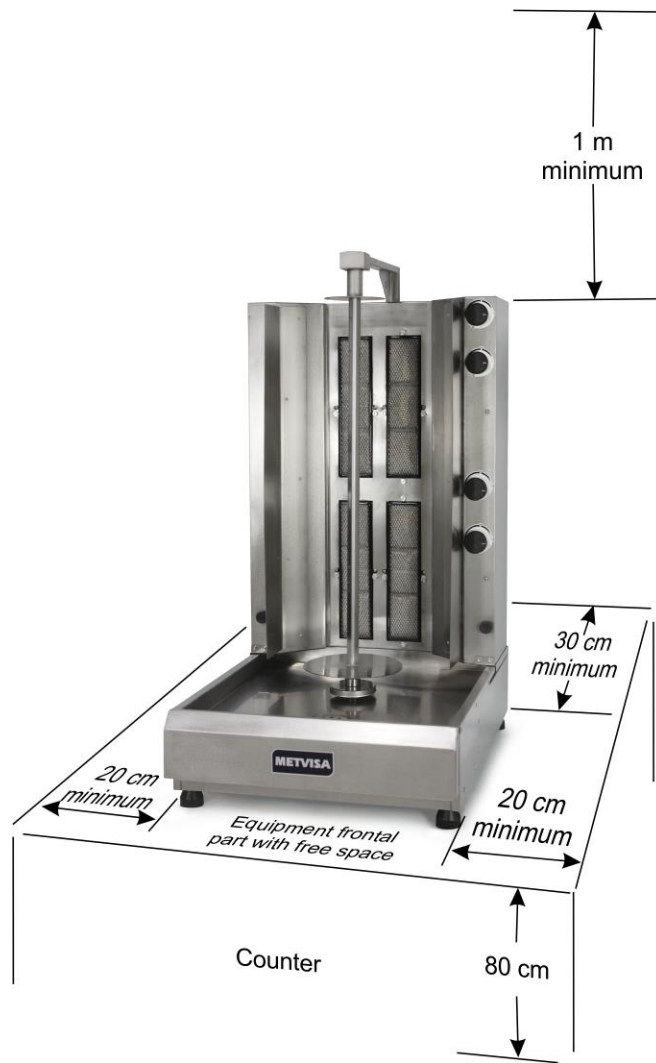

ATTENTION!

This equipment uses LPG (liquefied petroleum gas) for heating, and cannot be installed in closed environments where there is no air renewal, as this gas is highly toxic.

Keep the gas cylinder at least 1.5 m away from sockets, switches, electrical switches, or any device subject to sparks or flames, where these in contact with LPG gas could cause an explosion, causing serious accidents with risk of death to the operator.

Do not install the equipment near flammable materials or products.



ATTENTION!

The installation and the place where the equipment will be placed must comply with the rules of risk prevention and safety at work (Regulatory Norm NR-12 for Brazil or according to the regulatory standard in force in your country).

The manufacturer is not responsible for possible direct or indirect damages caused by non-compliance with said standards and other instructions presented in this manual.

3.2 Electrical Connection

The equipment is supplied with a power cord to be connected to an electrical network. If the power cord is damaged, it must be replaced with a new cord. The exchange must be carried out by the manufacturer, authorized agent or qualified person in order to avoid risks.

The plug type of the power cord varies by country. The equipment must be installed by a qualified technician for this function and in compliance with the regulations in force in the country, especially with regard to the grounding connection (if applicable).

Just below each pin on the plug, there is a marking corresponding to the pin: Phase, Ground (if applicable) and Neutral.

also comes with the equipment, an equipotential grounding terminal, located on the back of the roaster.

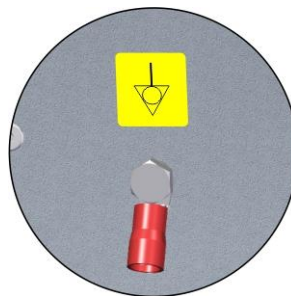

Equipotential
Grounding Terminal



The terminal identified in the figure aside is an additional protection to the grounding that is provided for in the electrical network, it must be connected to a grounding terminals, regardless of the connection to the electrical network, and the other products that have accessible metallic parts, and that are stationary, must also be connected to this bus as well as the service bench itself, if it is made of metallic material. In this way, all these products will be under the same electrical potential, avoiding undesirable leakage currents.

The roasters described in this manual are single voltage, 110V, 127V or 220V. If you need to change the voltage on your equipment, contact the manufacturer or authorized dealer.



ATTENTION!

Before turning on your equipment, always check that the mains supply voltage is the same as the equipment voltage. If it is not the same, contact the manufacturer or authorized dealer.

The supply voltage of this equipment is 110 V and 127 V (60 Hz) or 220 V (50 or 60 Hz) single-phase, as can be verified on the voltage label affixed to the power cable or as indicated on the nameplate data label, which is located on the right side of the equipment (see the figure on this label in item 2.2 of this manual).

Make sure that the voltage of the electrical network where the equipment will be installed is compatible with the voltage indicated on these labels.

For more details on the rest of the electrical part of the equipment, refer to the electrical diagram in the annexes of the manual.

IMPORTANT

The manufacturer is not responsible for possible direct or indirect damage caused by non-compliance with the rules and instructions presented in this manual.

3.3 LPG Gas Installation - Recommendations and Care

Check that the place where the equipment will be installed is ventilated and in accordance with the Rules for the Prevention of Risks at Work and Safety at Work on Machines and Equipment (Regulatory Norm NR-12), and periodic inspections by a technician are recommended to ensure that its components are in working condition.

The gas installation must be done by a qualified technician for this function and observing the safety rules.

The equipment must be installed with the following recommendations and items described below **BUT NOT SUPPLIED WITH THE EQUIPMENT**:

- **Gas cylinder** – for this equipment, 01 cylinder with a minimum mass of 13 kg (code P13) of LPG (liquefied petroleum gas) will be required. The cylinder must comply with the ABNT 8460 standard for Brazil or according to the regulatory standard in force in your country. Check the product warranty seal. If you have violated, do not install.
- **Pressure Regulator and Gas Register** – use only low-pressure regulator (2.8 Kpa) and with certification, embossed inscription NBR 8473. When installing the register on the cylinder, turn the butterfly nipple to the right, until it is firm. Never use tools to perform this operation.
- **Hose** – the INMETRO-certified model has the NBR 8613 engraving, made of transparent PVC plastic with a yellow stripe. The equipment is manufactured with connection for 1/2” hoses. The hose must not cross or be embedded in walls, and must not make any type of splice (welding or gluing). Fix the ends only with appropriate clamps. Never use wires or ribbons. Always check the expiry date of the hose.

IMPORTANT

In addition to the instructions given in this manual, it is also recommended to follow the cylinder manufacturer's instructions, as this item is not included with the equipment.

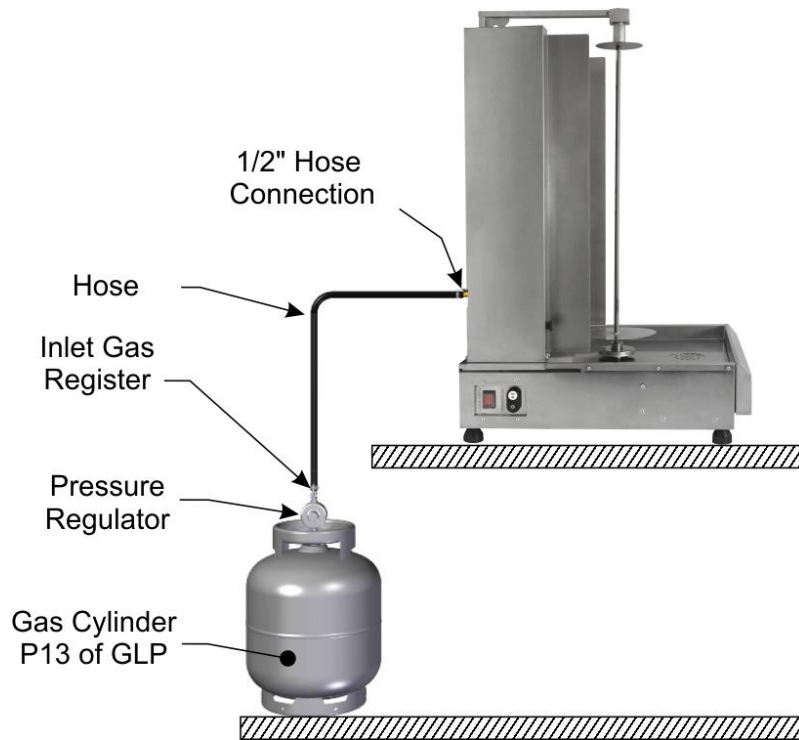

ATTENTION!

Change the pressure regulator every 5 years or when it is defective.

Always use the gas cylinder in an upright position. Never overturn, pour or tilt the cylinder, as the gas may flow into the liquid phase, canceling the pressure regulator function, which can cause serious accidents.

Never install the cylinder close to heated surfaces, and keep the gas conductive hose protected from heat so it does not melt, causing fire or other accidents.



ATTENTION!

This equipment operates with **LOW PRESSURE GAS**. If your supply network has high pressure, have the low-pressure outlet valve checked by a technician.

If the equipment is switched on at high pressure, the components will be damaged, in addition to creating risks for the operator.

After installation and for your safety, check for gas leaks using soap suds only. If there is a leak, inform the technician to repeat the installation.

If the leak persists, take the cylinder to a well-ventilated place and notify the company that sells or distributes the cylinder.

IMPORTANT

The manufacturer is not responsible for possible direct or indirect damage caused by non-compliance with the rules and instructions presented in this manual.

3.4 Safety Procedures and User Instruction

The professional who sells the equipment must instruct the user on the correct functioning of the equipment and must hand over this instruction manual.

The user must be informed of the necessary safety measures and must respect them, as well as all measures described in this manual.

Your equipment has mechanical protections (see item 1.2 Mechanical Safety). Removing or tampering with these safety components can cause serious risks to the operator's upper limbs

4. Equipment Use

4.1 Utility

This equipment is exclusively intended for roasting meat in general.

4.2 Commands

The equipment consists of gas regulator knobs (flame level) and on/off switch that are located on the right side of the roaster and main switch on the lower left side of the structure.

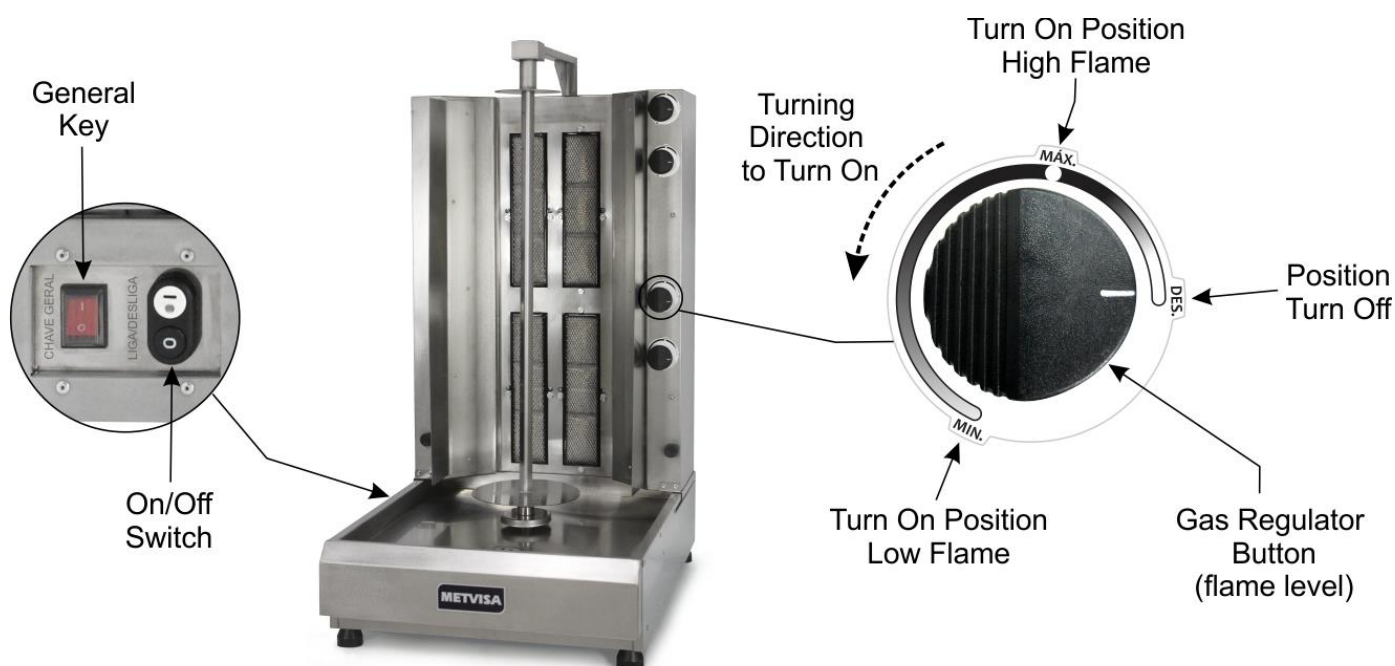

See description of each command below:

- **General Switch** – device used to safely activate and deactivate the electrical energy supply to the equipment. In position “1” it activates, in position “0” it deactivates power supply.
- **On/Off Button** – used to turn the motor that rotates the skewers on and off. In position “1” it switches on, in position “0” it switches off.
- **Gas Regulator Button** – used to light the infrared burners. To turn on, rotate counterclockwise. In the “MAX” position the flame will be high and at “MIN” the flame will be low. Rotate clockwise to the “OFF” position to turn off.

4.3 Operating Procedures

Before operating the equipment, perform perfect hygiene, especially of the skewer. The equipment is supplied with a protective film on the sheet metal parts that must be removed. Clean the equipment with the gas valve of the cylinder closed, the roaster at room temperature and disconnected from the electrical network. Follow the cleaning instructions in item 5 of this manual (below).

After these initial precautions, make sure that the gas hose connections are correctly fixed and that there are no leaks.

- **Operation:** The equipment can only be operated after checking the correct arrangement of the equipment, instructed in item 3.1, and after following the care and recommendations of the electrical connection and gas installation, according to the guidelines in items 3.2 and 3.3.

Check the skewer disassembly and assembly process below:

- **Disassembly:**

1. Before starting the disassembly process, disconnect the equipment from the electrical network;
2. Hold the skewer with one hand near the top coupling and with the other hand underneath from the base of the skewer;

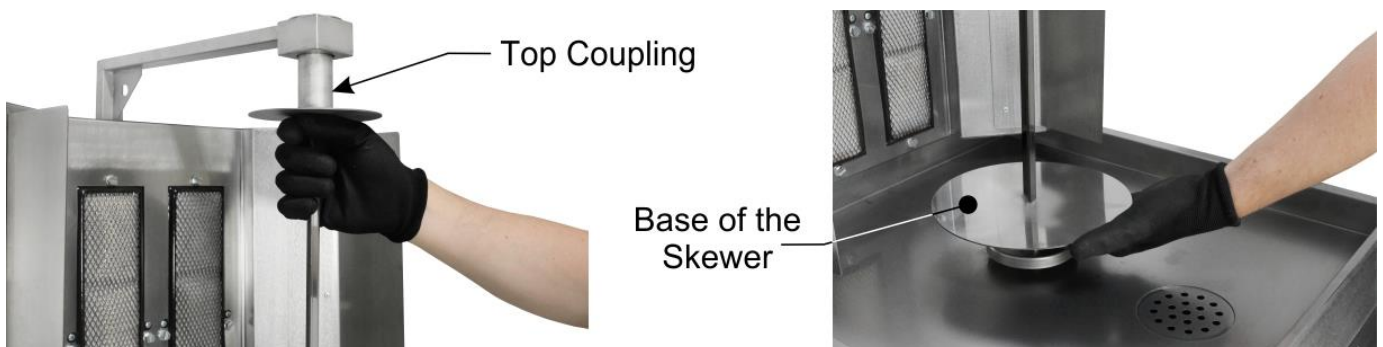

3. Push the skewer upwards until it disengages from the lower coupling and remove the skewer.

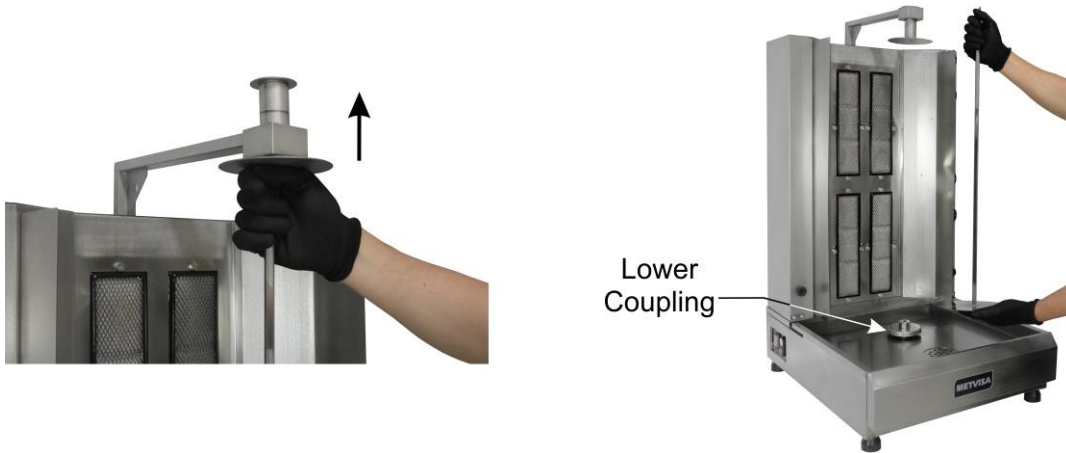

• **Assembly:**

1. With the skewer already sanitized, mount the piece or layers of meat on the skewer in a centralized way allowing the skewer to rotate freely. Always assemble the smaller parts of the meat on the bottom and the larger and more fatty parts on top;

The skewer has a capacity of 12 kg in the ACGE.2 model and 20 kg in the ACGE.4.

2. After filling the skewer with meat, fit the base of the skewer to the lower coupling and then to the upper coupling.



Check the following operating instructions:

1. The lighting of the equipment is manual. Open the gas pressure regulator (gas register);
2. Connect the power cord to the electrical network;
3. For correct and safe ignition, use an automatic type igniter and light in sequence from the top burner to the bottom. Press the gas regulator knob and turn to the on position;
4. With the lighter in hand, bring the tip up to 1 or 2 cm from the burner for lighting. The ceramic plate of the infrared burner gradually becomes glowing red.

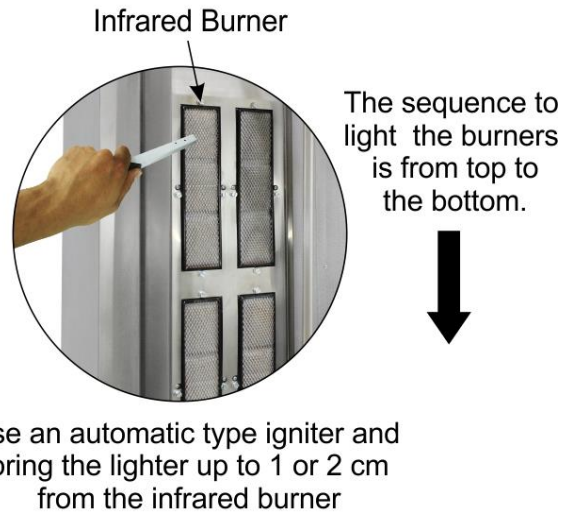
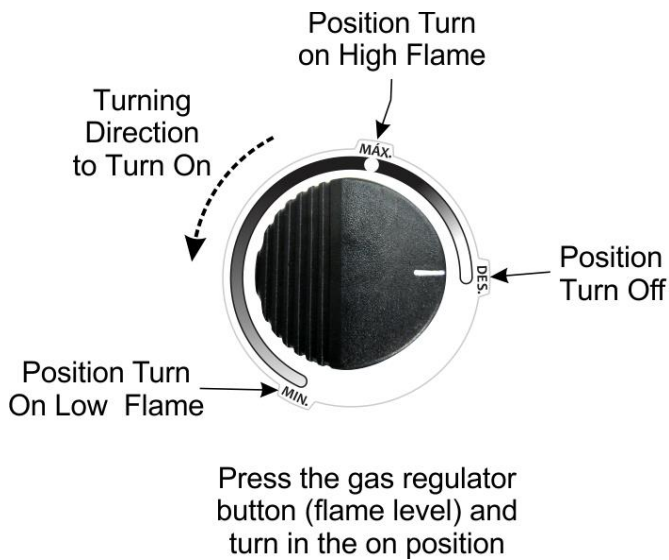

IMPORTANT

Only fit the skewer with the meat on the roaster with the burners off.

The automatic lighter does not come with the equipment, so always check the instructions for use on the packaging, which may vary depending on the brand and model.

On a cold day, lighting becomes more difficult, as the gas volatilizes more slowly, in which case a longer flame is required for lighting.



ATTENTION!

In case the ignition fails and you smell gas in the environment, do not light it.

Wait a few minutes for it to renew the air in the room, and only then turn on the equipment.

In case of any irregularity, contact the nearest authorized technical assistance service.

5. After lighting all the burners, turn the on/off button to position "1" (on). At this point the skewer starts to rotate;

TIPS

The equipment heats up more at the top. We recommend rotating the food so that the cooking is uniform.

When the food has reached the ideal color, turn the gas regulator knobs to the minimum flame or, if necessary, turn off 01 or 02 burners (ACGE.4) until the end of cooking.

The roaster has the possibility to move the burner structure to bring the burners closer or farther away from the meat in order to speed up or slow down the cooking.

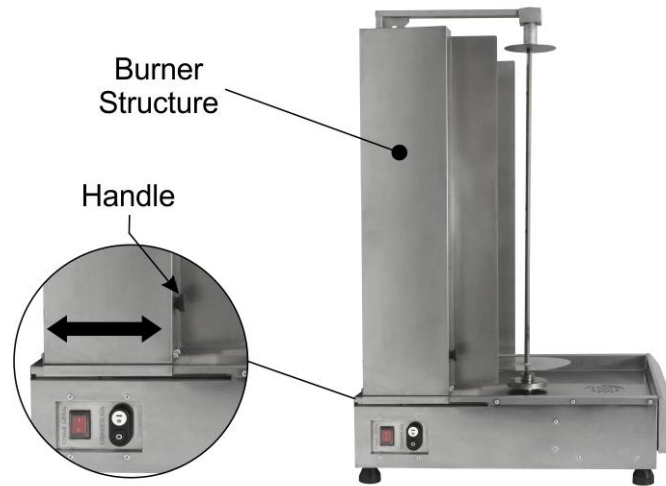

Move the burner structure using the handle.

6. To cut the roast meat layer, first turn off the skewer rotation by pressing the on/off button in position "0" (off);

By turning the motor off and on or by pressing the motor shaft, when cutting meat for example, the direction of rotation of the motor can be changed. Changing the motor's direction of rotation does not cause any damage to the equipment.



ATTENTION!

During cooking, keep a safe distance from the equipment to avoid burns.

Never turn on the roaster before placing the skewer with the meat. To remove the skewer from the roaster, turn off the motor and the burners.

Turn off the skewer rotation when cutting the meat, avoiding burns.

Do not insert food beyond the capacity of the equipment.

Do not place your hands, utensils and objects on the heated roaster, as there is a risk of burns, overheating and accidents.

Always keep the fat collector attached to the equipment and empty it constantly, in this way, excess fat is prevented from overflowing and leakage.

Failure to comply with this guidance will be considered an unsafe act and abusive use of the equipment.

7. After the work is finished, press the on/off button to the "0" (off) position and turn off the burners by rotating the gas regulator knobs to the "OFF" position. (turn off). Close the gas pressure regulator (gas valve).
8. Wait for the equipment to reach room temperature before removing the skewer and cleaning.



ATTENTION!

During operation, hot vapors and splashes of superheated oil or grease may be emitted. Always use PPE (Personal Protective Equipment).



ATTENTION!

After finishing the work and turning off the burners, close the gas pressure regulator (register), because if it happens to be left open, the pressure exerted on the hose could damage it or break it, which could cause fire or other accidents.

IMPORTANT

Do not start the cooking process if there is food residue on the skewers, this can lead to bacterial contamination.

IMPORTANT

The manufacturer is not responsible for possible direct or indirect damage caused by non-compliance with the rules and instructions presented in this manual.

5. Cleaning and Maintenance

5.1 Cleaning Procedures and Products Used

Your equipment was built with first-line materials, so use it properly and you will obtain great satisfaction. Always keep your equipment clean and well-cared for, which will make it much more durable.

Daily cleaning of the equipment must be carried out for good operation and durability. Preventing the accumulation of bacteria which can cause contamination in food.

If your equipment is supplied with a protective film on the stainless steel parts, it must be removed before the first cleaning.



ATTENTION!

Before carrying out maintenance or cleaning, make sure that the on/off switch is in the “0” (off) position, that the plug is disconnected from the mains, the gas valve of the cylinder is closed and the inside of the rotisserie at room temperature.



ATTENTION!

Do not use water jet or steam cleaner to clean the equipment.

IMPORTANT

This equipment is not intended to be immersed in water for cleaning.

Follow the instructions below to learn what special care is taken with the equipment.

Removable parts (skewers and grease collector) must be removed from the equipment and washed with soap and water or neutral detergent. Clean the corners well, eliminating process residues.

Clean the inside and outside of the roaster as often as possible to prevent food residue from drying and sticking to the parts. For cleaning, dilute the mild soap or detergent or ammonia-based remover in warm water and apply with a soft cloth. With a cloth dampened with water, rinse and then dry the parts with a soft, dry cloth.

To clean the infrared burner, use only a soft brush. Do not use water as the burner plate must not be wet.

Never use abrasive products or sponges (soap, brushes or steel wool), solvents or substances containing acids or chlorine to clean metal parts, as they can scratch or damage the surface of the parts causing corrosion points. Do not spill water on the motor and electrical parts for cleaning, otherwise, when turning it on, it may cause an electric shock or even burn the equipment.



ATTENTION!

It is extremely important that the products used for cleaning ensure maximum hygiene and that they are non-toxic.

5.2 Breakdown Maintenance and Procedures

The operator must be instructed to carry out routine inspections, making small adjustments, cleaning and observing signs of breakdowns that may occur. Examples include: checking for strange noises indicating gas leaks; burners that do not light; the non-execution by the equipment to the service to which it is proposed; among others. Actions like these are indispensable to guarantee a longer equipment life.



ATTENTION!

When maintenance is carried out (even if minor adjustments are made), always check that the equipment has the burners off, the pressure regulator (register) of the gas closed and the equipment be at room temperature.

It is recommended that each 6 months be made preventive maintenance, checking and adjusting the loose, cleaning the internal parts, and others. Detecting broke parts or without the correct functionality the worker needs to exchange the parts, always using original parts only.

By carrying out preventive maintenance, the inconvenience of having the equipment stopped when it is most needed is eliminated, the cost of maintenance is reduced and the risk of accidents is reduced.

Follow the equipment maintenance and adjustment recommendations:

- Change the pressure regulator every 5 years or when it is defective;
- After use, keep the gas valve closed, avoiding pressure on the hose;
- The gas injector on the burner must always be unobstructed. If they become clogged, use a needle for cleaning on stove tops;



ATTENTION!

Preventive maintenance requires a trained professional.

Whenever an item related to the safety of the equipment is removed (such as when performing maintenance), put it back in its proper place and confirm that they are performing their function correctly.

Detecting broke parts or without the correct functionality, please contact the nearest authorized service center.

5.3 Prolonged Interruption in Use of the Equipment

When you have to leave the equipment stopped for an extended period of time, perform a thorough cleaning, including the accessories. It is advisable to protect all parts of the equipment with white petroleum jelly or with suitable products that are commercially available. You must also protect the equipment from dust by covering it with a nylon or other material.

6. Analysis and Troubleshooting

6.1 Problems, possible causes and solutions

IMG quality products are designed with materials and components that guarantee a longer service life for your equipment. However, due to natural wear, improper use or lack of maintenance, the equipment may have irregularities in its operation.

In the following table, you can see possible causes and solutions:

PROBLEMS	POSSIBLE CAUSES	SOLUTIONS
Burners do not light or the skewers do not rotate.	Lack of electricity or gas.	Check if there is energy in the network or gas in the cylinders. Check that the power cord is plugged into an outlet.
	Equipment voltage different from mains voltage.	Send the equipment to the nearest authorized service station or contact the factory.
	Several electrical problems (motor/capacitor, power cable and buttons).	
Skewer rotation stops in the middle of the operation	Lack of electricity	Check if there is power on the network. Check that the power cord is plugged into an outlet.
	Several electrical problems (motor/capacitor, power cable and buttons).	Send the equipment to the nearest authorized service station or contact the factory.
Infrared burners do not light	Lack of gas.	Check if there is gas in the cylinder, if the gas cylinder valve is open, if the gas hose is connected and if the gas regulator is open. Never install just a single gas cylinder, as this cylinder may freeze.
	Clogged gas injector.	Clear burner holes, as instructed in item 5.2 (Maintenance) Send the equipment to the nearest authorized service station or contact the factory.
	Gas Leak.	See below for possible causes and solutions for gas leakage (page 21 and 22).

Gas Leak.	Burst, loose or broken record.	Send the equipment to the nearest authorized service station or contact the factory, as there is a risk of accidents.
	Register injector out of position.	Send the equipment to the nearest authorized service station or contact the factory. There is a risk of accidents.
	Defective gas cylinder.	Check for gas leaks using soap suds only. If there is a leak, inform the technician to repeat the installation. If the leak persists, take the cylinder to a well-ventilated place and notify the company that sells or distributes the cylinder.
	Gas cylinder installed in horizontal position.	Install the cylinder in a vertical position. Never turn, lay down or tilt the cylinder, as the gas may flow in the liquid phase, canceling the function of the pressure regulator, which could cause serious accidents.
Equipment that smells of burning or smoke.	Equipment voltage different from mains voltage.	Send the equipment to the nearest authorized service station or contact the factory.
	Several electrical problems.	
	Burnt food	Too high temperature and/or baking time.
It takes time to warm up.	Dirty roaster.	Clean the rotisserie, according to the guidelines in item 5.1 (Cleaning Procedures).
	Gas shortage or failure.	Check if there is gas in the cylinder, if the gas cylinder valve is open, if the gas hose is connected and if the gas regulator is open.
Roaster giving shock	Lack of grounding.	Follow the instructions in item 3.3 (Electrical Connection).
	Several electrical problems.	Send the equipment to the nearest authorized service station or contact the factory.

For more information and clarification, contact the Authorized Technical Assistance nearest you. See list of technical assistance on our website: www.metvisa.com.br

7. Useful Life of the Equipment and its Components

The equipment's useful life can vary from 3 to 5 years depending on the proper use, cleaning, maintenance and quality of its components.

Below is the useful life ratio of the main components:

- On/Off Switch: 10.000 uses;
- Main Switch: 10.000 uses

8. Applicable Standards

The Brazilian standards applied for the development of the equipment and preparation of this manual are:

- IEC 60335-1;
- IEC 60335-2-64;
- Portaria 148 de 28 de Março de 2022 do INMETRO;
- NR-12 - Portaria 197 de Dezembro de 2010;
- Applicable Technical Standards (ABNT NBR, ISO IEC).

This manual can be found at www.metvisa.com.br/downloads.

9. ANEXXES

Electrical Schematic

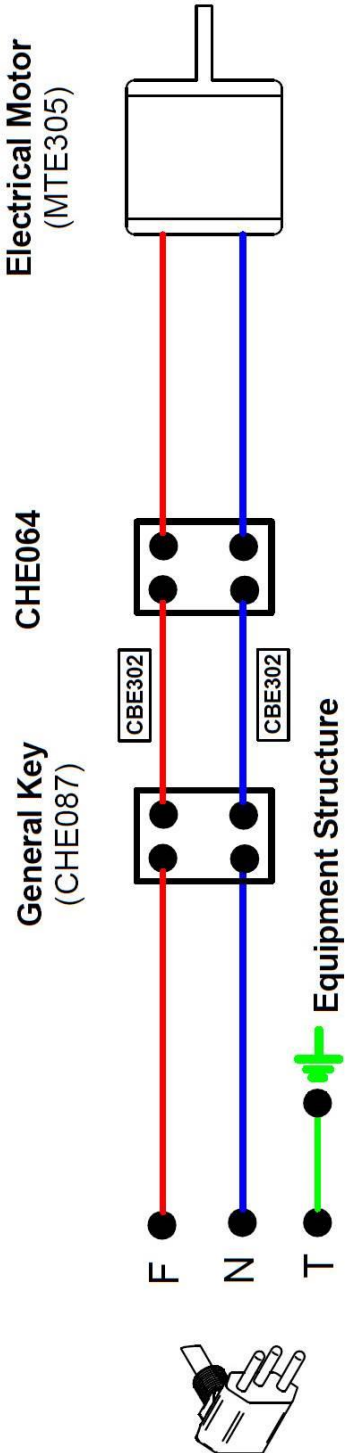

ATTENTION: For electrical installation, observe the current regulations in the country, especially with regard to the grounding connection (if applicable).

Exploded View Drawing

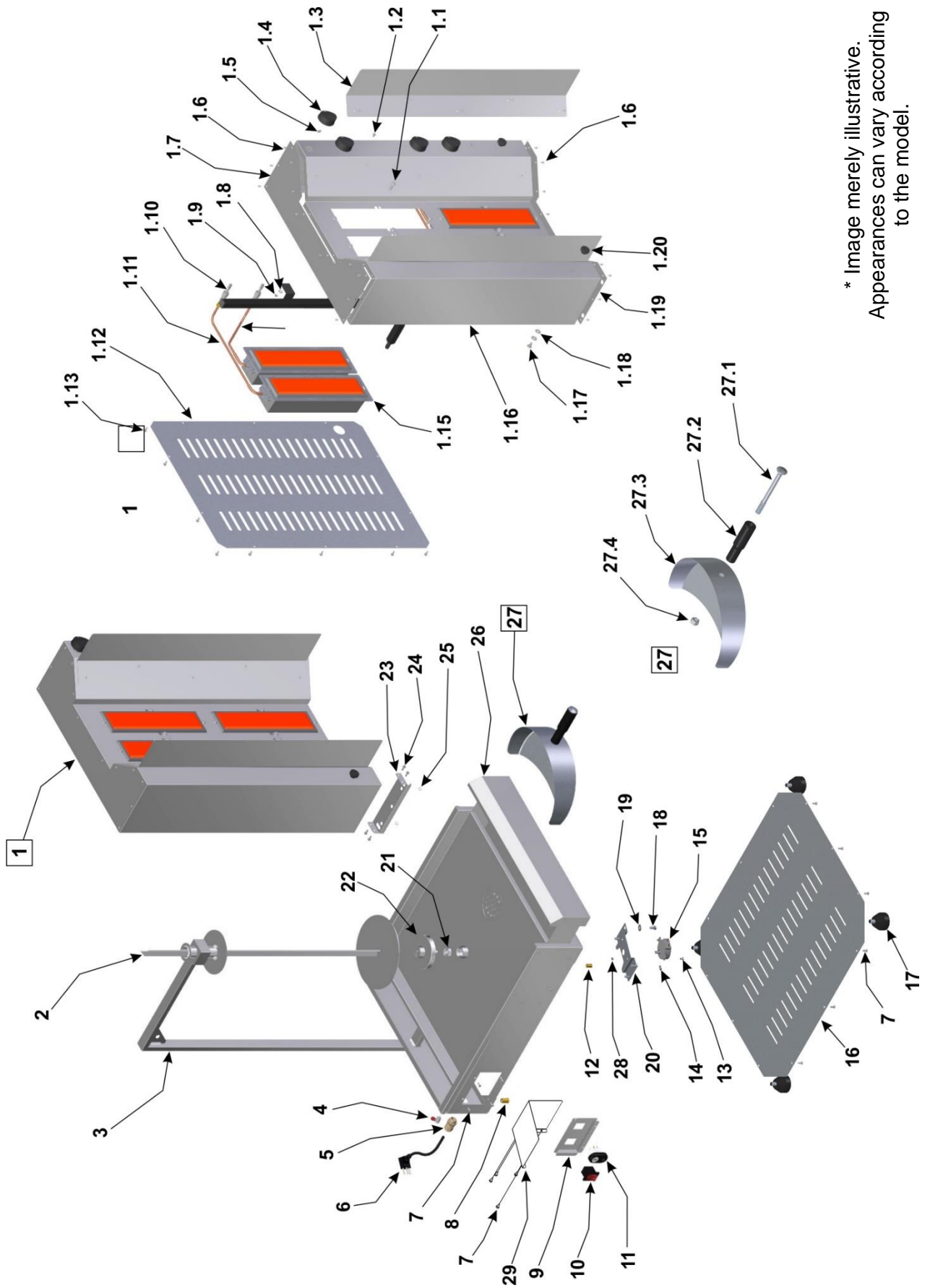

* Image merely illustrative.
Appearances can vary according to the model.

Spare Parts List

Position	Code	Description	Quantity	Model
1	CJT1133	Structure Set	01	ACGE.2
	CJT1097		01	ACGE.4
1.1	PRA022	Drilling Hex Screwdriver	08	ACGE.2
			16	ACGE.4
1.2	PRR017	Stainless Steel Round Machine Screw	02	*
1.3	PTC227	Knobs Protection	02	ACGE.2
	PTC223		02	ACGE.4
1.4	BOT021	Gas Regulator Knobs	02	ACGE.2
			04	ACGE.4
1.5	CRC783	Registration Support	02	ACGE.2
			04	ACGE.4
1.6	RBT001	Rivet	30	ACGE.2
			34	ACGE.4
1.7	CRC1369	Upper Coating	01	*
1.8	ARL008	Flat Washer	02	*
1.9	POS016	Stainless Steel Hexagon Nut	02	*
1.10	CJT1135	Distribution Set w/ Valves	01	ACGE.2
	CJT1101		01	ACGE.4
1.11	CJT1098	Gas Feed Set	01	ACGE.2
			02	ACGE.4
1.12	CRC1439	Back Coating	01	ACGE.2
	CRC1405		01	ACGE.4
1.13	PRA014	Stainless Steel Drilling Hex Screw	14	*
1.14	CJT1099	Set Gas Supply with 45° Tilt	01	ACGE.2
			02	ACGE.4
1.15	CJT924	Infrared Burners	02	ACGE.2
			04	ACGE.4
1.16	GAB249	Structure	01	ACGE.2
	GAB227		01	ACGE.4
1.17	PRR009	Machine Round Screw	02	*
1.18	ARL010	Stainless Steek Flat Washer	04	*
1.19	CRC1368	Lower Closure	01	*
1.20	MNL011	Internal Thread Handle	02	*
2	CJT1132	Skewer	01	ACGE.2
	CJT1096		01	ACGE.4
3	CJT1131	Fixed Structure Set	01	ACGE.2
	CJT1095		01	ACGE.4
4	CJT704	Grounding Terminal	01	*
5	TCE019	Cable Gland	01	*
6	CBE142	Electrical Power Cord Type 5	01	**
	CBE030	Electrical Power Cord Type 4	01	**
	CBE029	Electrical Power Cord Type 2	01	**
	CBE023	Electrical Power Cord Type 1	01	**
	CBE023	Electrical Power Cord Type 3	01	**

* Item applied to all models of ACGE roasters.

**Contact factory service or technician for replacement parts.

Spare Parts List

Position	Code	Description	Quantity	Model
7	RBT004	Rivet	16	*
8	RBT020	Extra Fine Body Rivet	04	*
9	CRC1404	Panel Sheet	01	*
10	CHE087	Electric Key Beep. (red)	01	*
11	CHE064	On/Off Switch	01	*
12	RBT018	Extra Fine Body Rivet	04	*
13	PCC013	Stainless Steel Cylindrical Screw	02	*
14	PRN012	Allen Screw	01	*
15	MTE305	Motor 4 W 3 rpm 220 V 50/60 Hz	01	*
15	MTE309	Motor 4 W 3 rpm 110/127 V 50/60 Hz	01	*
16	CRC1403	Lower Coating	01	*
17	PEP028	Rubber Feet	04	*
18	PRS324	Stainless Steel Hex Screw	04	*
19	ARL010	Stainless Steel Flat Washer	04	*
20	SBT546	Motor Support	01	*
21	ROL055	Bearing	01	*
22	CJT1045	Coupling with Protection	01	*
23	GIA107	Guide Sheet	02	*
24	PRA014	Stainless Steel Drilling Hex Screw	08	*
25	TVS005	Round Hole Cover	04	*
26	CJT1046	Fat Tray Set	01	*
27	CJT1050	Spatula with Handle	01	*
27.1	PRF008	French Screw	01	*
27.2	MNL062	Plastic Handle	01	*
27.3	CJT1049	Spatula	01	*
27.4	POS010	Hexagon Nut	01	*
28	POS138	Hexagon Nut	02	*
29	CRC1563	Electrical System Coating	01	*
30	- - - -	Electrical Cables and Connectors below:	- - - -	*
30.1	TCE004	Female Faston Isolated Terminal (Blue)	05	*
30.2	CBE302	Electric Cable Splice 120 mm - Section 0.75 mm ² (Black)	02	*
30.3	CBE306	Electrical Whip Motor Connection 450 mm	02	*

* Item applied to all models of ACGE roasters.

**Contact factory service or technician for replacement parts.

IMG BRASIL PRODUCT MANUFACTURER

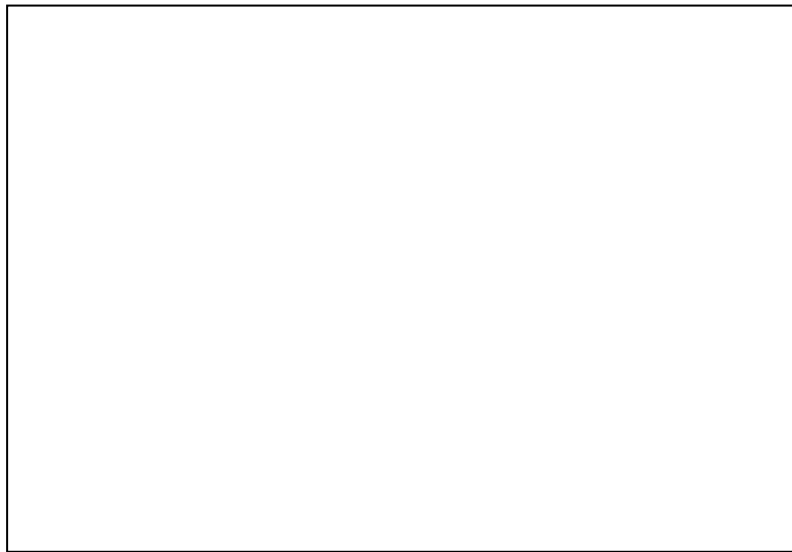

IMG-BRASIL Gastronomy Machinery Industry Ltda.

CNPJ 11.193.347/0001-14 - CREA 131726-3

Road. Antônio Heil - KM 23 Nº 5825 - Neighborhood: Limoeiro

ZIP CODE 88352-502 - Brusque - SC - Brazil

Phone/fax. +55 47 3251-5555 - Web Site: www.metvisa.com.br

Mail: sac@metvisa.com.br - export@metvisa.com.br



See more of our complete
line of products.